

Pneumatic automation for industry 4.0



Nowadays numerous aspects of the industrial world are attributed to the Industry 4.0 revolution. This article aims to highlight aspects of managing operational data, lifetime and diagnostics for processing machinery. Too often, anyone dealing with this subject underestimates, or even forgets, the quantitative and qualitative importance of data managed at machine level, which is actually more extensive and requires special processing.

Industry 4.0 data management procedures are often associated with a pyramid, with ERP at the top, progressively leading down to the management of processing machinery, implemented with protocols such as OPC UA protocol. The fact is that every processing machine has hundreds of components to be managed - actuators, pneumatic cylinders, electric motors, limit

switches, pressure regulators or temperature gauges. Therefore data managed at the top level is actually just the tip of the iceberg, compared with the data to be managed at the lowest level, i.e. inside the machine. This is the level where pneumatics operate.

The most common, but least efficient, approach is to entrust this to the machine PLC. However the PLC, and in particular the person programming it, already has numerous things to consider, without having to focus on the intelligent management of statistical, diagnostic and preventative maintenance data for individual actuators or sensors. The result is that this information, which is essential for the satisfactory operation of the entire system, is ignored and not managed - similar to having a pyramid built on clay.

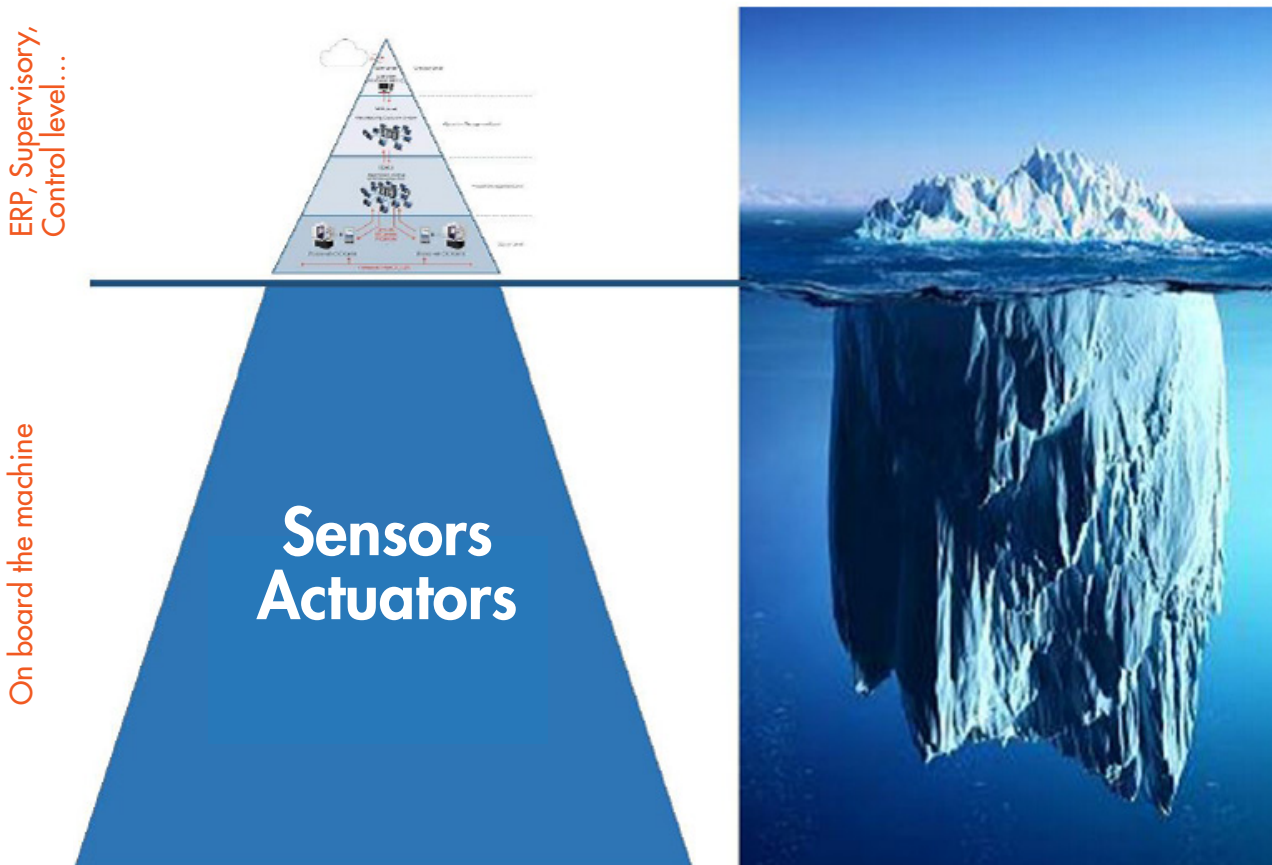

Figure 1: The i4.0 pyramid. Sensors and actuators, i.e. the world of pneumatics, are the part of the iceberg which is submerged.

An electro-pneumatic system for i4.0

To address this issue Metal Work has produced the EB80 Electro-Pneumatic System. This basically leaves the PLC to handle work cycles, sequencing and machine checks, while the EB80 system transmits its decisions to the actuators/sensors, checks everything is operating satisfactorily, and flags a warning when a component malfunctions or has reached its expected lifetime.

Let's look at the EB80 system in more detail.

The heart of the EB80 electro-pneumatic system is the electrical connection module E. This is the nerve centre that exchanges information with the PLC and distributes it to valves, sensors and actuators. The information exchanged includes real time information, such as commands to open a valve or receive a signal from an excited sensor, in addition to diagnostics and historic data for i4.0. The E modules are extremely modular, consisting of a lower part which is always the same, and an upper part that differs depending on the field bus. It is therefore possible to replace only the upper part in the event of a bus fault, or replace one type of bus with another without having to dismantle the solenoid valve island. The E module has been designed to operate even in the presence of electrical disturbance (EMC), humidity (IP65) and supply voltage surges - just think that input voltage can be between 10.8V and 31.2V and the system will operate as it should.

The E module has the pneumatic features secured on one side, on the right for example, including solenoid valves and other components such as pressure and flow regulators, which will be discussed further on. The left has the part which manages input and output signals. The solenoid valves are secured to modular bases, with modules with 3 or 4 positions (patented) to be able to freely assemble units with 3 to 180 valves. These bases with 3 or 4 positions are an essential i4.0 feature.

Each has a processor that stores a significant amount of data on the valves secured to them. It is possible to know how many times a valve has been excited, total excitation time, and whether or not there were short circuit or open circuit alerts. Additionally, the processor sends a signal when a valve has exceeded 60% of its expected lifetime, providing a powerful preventative maintenance tool. This information is stored for 50 years!

The following valves can be fitted: 2/2 NC, 3/2 NC or NO, 5/2 mono-stable or bi-stable, 5/3. Flow connections are automatic fittings for metric pipes (4, 6, 8, 10 mm) or in inches (5/32", 5/16", 1/4", 3/8"). The maximum capacity is 800 NI/min with pipes with a diameter of 8 mm and 1400 NI/min for a special higher capacity valve with pipes with a diameter of 10 mm (pat.).

If the actuators controlled by the solenoid valves are positioned in parts of the machine that are not close



Figure 2: EB80 is a dedicated i4.0 electro-pneumatic system.

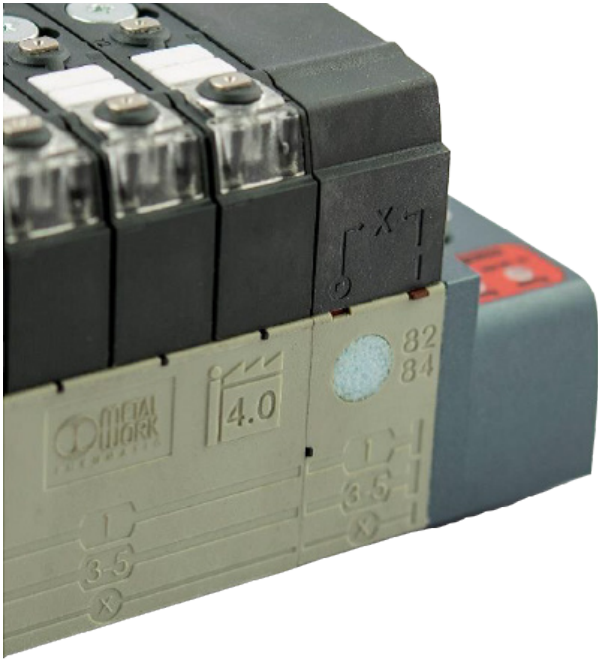

Figure 3: Each valve base has an i4.0 data storage microchip.

together, and lengthy air pipes are not desirable, EB80 enables the addition of slave valve sets at a distance of up to 40 m from the master solenoid valve island with an additional E module, avoiding the addition of field bus nodes. More than one additional module can be arranged in series and connected together by a cable with an M8 connector. Let's now look at the left side of the E module, handling signal management.

First of all it should be highlighted that, in total, each EB80 system can manage up to 336 signals and exactly 128 digital inputs (e.g. sensors), 128 digital outputs (e.g. decentralised flow valves or hydraulic valves), 40 analogue inputs (e.g. flow or position transducers), 40 analogue outputs (e.g. proportional valves), and 16 thermocouples or thermistors. There are variants with M8 connectors or terminal boards. This left side of the system also has dual modularity defined as horizontal, which enables one or more modules to be added at any time, and modularity defined as vertical, which enables just the upper part of the module to be replaced without dismantling the solenoid valve island, either because it is faulty or is to be replaced with a different type.

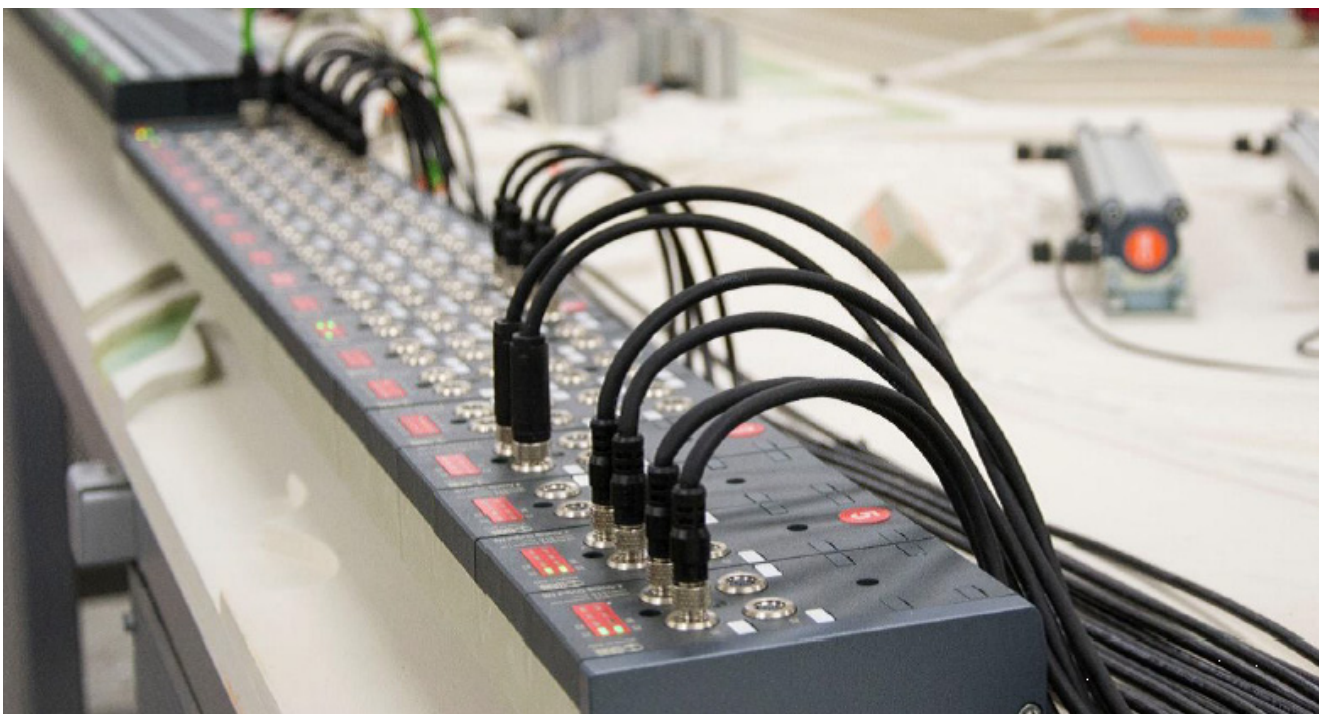

Figure 4: EB80 manages actuators and sensors in analogue and digital mode.

Maintenance and diagnostics

During the product development phase increased effort was placed on reducing fault risks. Obviously fault diagnosis is important, but even more important is reducing or possibly eliminating faults.

A failure mode and effects analysis (FMEA) was therefore carried out, cutting-edge simulation tools were employed, and numerous field and laboratory test sequences were performed. Prevention was pursued in painstaking fashion. Examples include placing a HDPE filter at the solenoid valve air inlet, to prevent dirt from reaching the most delicate part of the valve. M4 screws secure the valves to the bases in place of the M2.5 or M3 screws more frequently used by other manufacturers. The valve set interior is slightly overpressure to prevent the infiltration of pollutants. Furthermore, an internal pressure relief valve safeguards against air leaks inside the solenoid valve island. As mentioned, surge voltages or accidental voltage reductions will not hinder operation, which is guaranteed between 10.8 V and 31.2 V.

In order to facilitate the intervention of the operators, special care was taken over the user interface: all the information and objects on which to operate are only on one side of the solenoid valve island: the LED lights, pneumatic diagram, code, manual controls, personalised customer plate and setscrews. The solenoid valve island assembling and any changes to the valves, fieldbus module and input and output modules must be done only using a Philips screw.

Let's now discuss diagnostics, which is the pinnacle of the EB80 system and what qualifies it as a truly i4.0 component. There are **4 levels of diagnostics**.

The **lowest level** consists of an LED warning light for each valve position, signal module and electric E module. The LED warning system flags conditions relating to solenoid valve short circuits, interrupted or missing solenoid valves, surge voltages, insufficient voltage, and interrupted electrical signal transmission. Every red LED can transmit these messages by modulating intermittent operation.

It should be remembered that a visual warning is important in troubleshooting. Even if the error signal is sent via software to higher level management systems, the ability of maintenance engineers to immediately see what is happening, and where, saves considerable time.

The **second level of diagnostics** consists of storing statistical data within the solenoid valve island. We have already explained that every valve base module has autonomous intelligence, as does the electric E module. The result of having decentralised the data means it will not be lost, even in the long term and for up to 50 years, not even if the solenoid valve island is modified or dismantled. This is a considerable advantage for machine suppliers' quality assurance departments. Let's consider a few examples. Suppose a customer returns a complete valve base for repair, saying it doesn't work sometimes. Reading the historic data may reveal that the supply voltage dropped below the threshold 30 times, therefore the issue is due to the customer's unsatisfactory electricity supply. Or it is noted that a valve has already completed 230 million cycles, and therefore exceeded its expected lifetime and should be replaced.

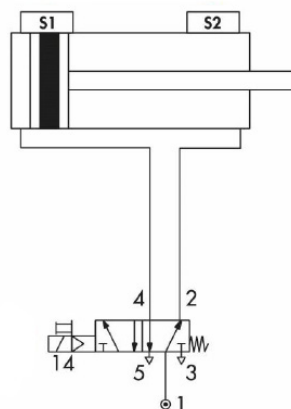
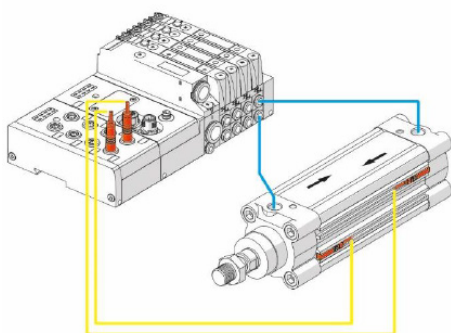

Figure 5: The system also manages connected actuators, number of cycles, speed, delays and faults.

The second level of diagnostics also includes a set of algorithms that enable the system to check the operation of actuators controlled by the solenoid valves.

We shouldn't forget that a typical use of valve sets is the operation of pneumatic cylinders, normally with limit switch sensors fitted that read piston position. The digital signals sent from the sensors are read by EB80 input modules, closing a cylinder control loop. The solenoid valve island controls the movement of the cylinder and reads the signal linked to the movement. This is all implemented locally, without involving the PLC. As a result, the solenoid valve island can evaluate potential cylinder operation delays that could, for example, be due to faults, pipe interruptions, seized components or any other issue. The reference time of operation and corresponding acceptance threshold can be set, and an error message is generated in the event of variations.

The third application which can be implemented is cylinder speed control. Similarly to above, EB80 can obviously control cylinder motion in both directions and read signals generated by the two limit switches. As a result it can measure and monitor the average speed of the cylinder and the number of strokes completed.

The solenoid valve island can therefore store the distance travelled and monitor speed changes that could, for example, be due to setting modifications, increased friction or changes to applied loads. An unexpected drop in speed can cause a fall in productivity, whereas an abrupt increase can cause the breakage of actuators or mechanical machine parts.

In this case too, a reference value for speed and an acceptance threshold can be inserted. In the event of unexpected changes an error message is generated, which can be managed by the user. It should be reiterated that local verification is involved, in real time and directly in the field, without having to develop additional control system applications. This makes EB80 an extremely powerful and flexible smart component, without the need for other modules in addition to the standard version.

The **third level of diagnostics** is the transmission of diagnostic data directly from the E module to the PLC, using the field bus cable.

The **fourth level of diagnostics** is the option of sending data remotely to a centralised management system, or via the cloud by means of a gateway, to operators who can see what is happening at any time and provide remote support.

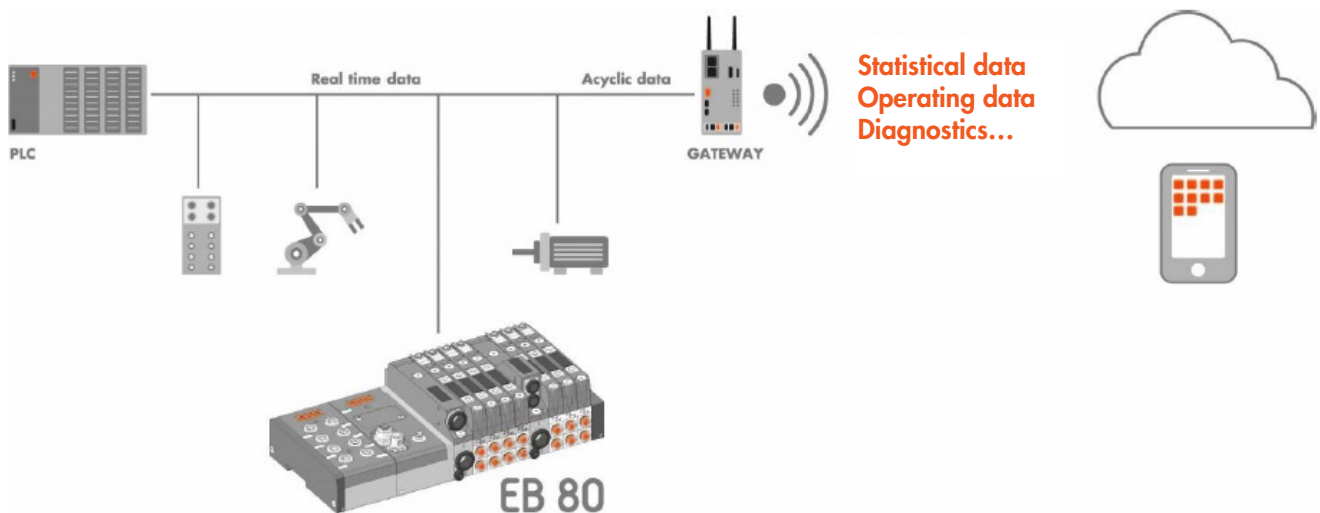

Figure 6: EB80 can send historic, statistical and diagnostic data over the cloud.

It should be noted that this information is required not only in the event of a fault, but also for knowing if the machine is operating, which valves are activated at a given time, and how many cycles they have completed. For example, it could be useful to know that a certain valve has already completed 60% of the cycles expected in its lifetime, in order to replace it as a precaution at the first opportunity. This information can be read by any remote device, such as a smartphone, by simply reading the QR code for the system in question.



Figure 7: Possibility of checking data for each valve and cylinder remotely.

“I care”, the system also handles management

The considerable power and flexibility demonstrated by EB80 in managing cylinder sensors and valves led our customers to asking why it couldn't be possible to have EB80 also handle other machine input and output, and not just pneumatic information. And what about electric axle drives?

Therefore as mentioned, the modules that manage singles were increased in number and available options, so it would be possible for EB80 to handle, for example, a flow rate meter, a proportional valve and temperature gauges.

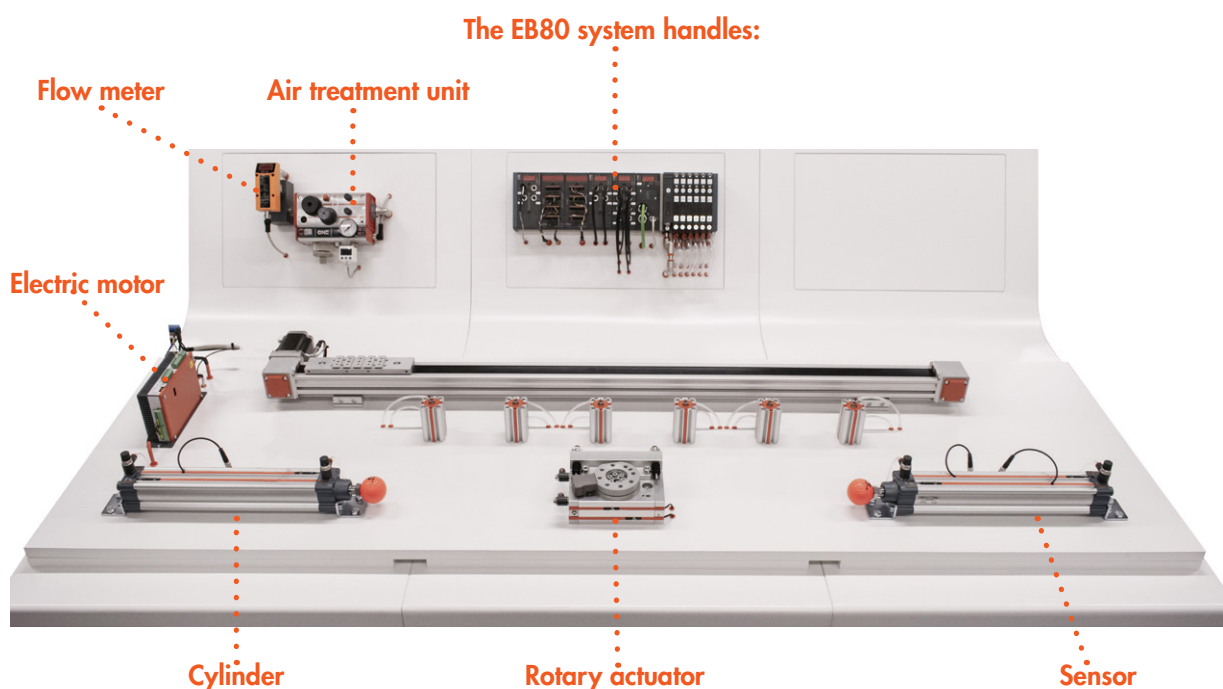

Figure 8: Industry 4.0 applications with EB80.

The real innovation, however, has been the development of a device called E-motion, which enables communication between any make of motor, of any power, with all field buses, via EB80. As a result, anyone wanting to manage stepper or brushless motors with a specific field bus (Profibus-DP, Profinet IO, EtherCAT, EtherNet, CANopen, Powerlink, CC-Link), does not have to find the drive with the interface for that specific bus - EB80 can handle it. The only requirement of the drive is to have step-direction commands, which is fairly widespread.

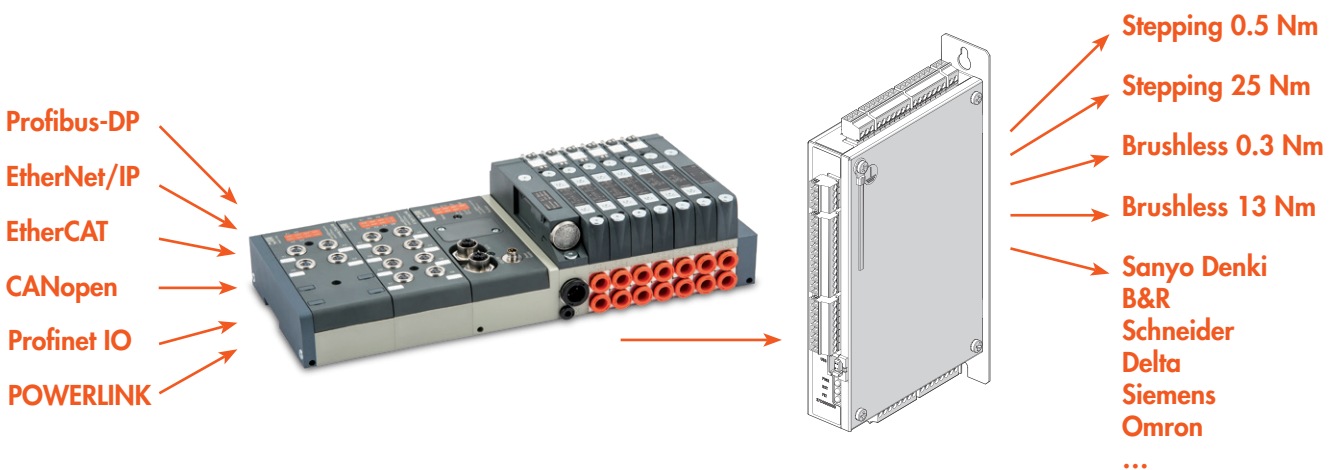

Figure 9: The E-motion device enables any type of field bus to be connected to any make/power of stepper or brushless motor.

At this point customers also asked whether or not EB80 could be equipped with various pneumatic functions, not just solenoid valves.

This led to the multi-purpose fittings (patented), miniature parts to be directly connected to the valve base outlets, with the following functions: pressure regulator, flow regulator, check valve, calibrated choke valve, 2 or 3-way disconnection valve, quick release valve, pneumatic valve.

The EB80 system has various other aspects worth mentioning, such as energy savings obtained with solenoid valves that develop power of 3 W for a few milliseconds - just the time required to ensure switching speed and power - that then drop to maintain 0.3 W, reducing electricity consumption by 90%, compliance

with international standards, including environmental ROHS and REACH standards, and those relating to flammability and explosive atmospheres, Atex, UL, CSA and IECEx, and the option of creating all types of pneumatic layouts, thanks to modules with special pneumatic and/or electrical supplies that can be inserted anywhere in the solenoid valve island.

This presentation of the EB80 system, which is probably the most comprehensive and versatile in the world of pneumatics for the Industry 4.0 revolution, has shown that it can handle not only solenoid valves, but also cylinders, sensors, transducers, electric motors and the satisfactory operation of the entire system.

2020 – year of compressed air treatment

Machinery constructed for the Industry 4.0 revolution must focus on the reliability and connectivity of all elements.

The air treatment unit is an important component and is often undervalued. Compressed air is the fourth energy resource after gas, water and electricity, and in many companies represents the main energy cost. Unlike other energy sources, compressed air is generated and processed directly at the user's site, therefore its quality and costs depend on that user's choices. It is essential to provide machinery with clean air at a constant pressure, and safe startup and discharge systems.

Providing clean air means ensuring machines have a long lifetime. Conversely, air polluted by solid, liquid or oily particles can damage pneumatic parts, resulting in economically disastrous machine downtime. We know that solid particles can block transit, especially pneumatically controlled transit, and wear out surfaces. The water present in air removes long-life lubricants in cylinders and valves, and oxidises surfaces. Oil, unless required by certain actuators (e.g. screwdrivers), removes long-life lubrication, changes friction, and when the air is discharged into the atmosphere, fouls and pollutes the entire system.

Pressure regulation determines the speed and repetition of pneumatic motion and affects consumption and costs.

Finally, the start-up and discharge system affects cycle start/end movements and the safety of the system and operators. Soft starters ensure that when a machine

is switched on there are no fast, uncontrolled cylinder movements. Safe discharge systems, such as the Metal Work SAFE AIR series, are necessary to ensure that system pressure is definitely zero before an operator or maintenance engineer enters the work area.

These topics are so important, yet so often neglected, that Metal Work decided to launch an information campaign, declaring 2020 as the YEAR OF COMPRESSED AIR TREATMENT. The campaign involves the supply of paper and online brochures, technical courses, theoretical or field verification for energy planning and optimisation for units, and promotional activities, reserving special prices for anyone deciding to change to Metal Work's quality air treatment systems.

Metal Work has 7 different product lines in this area: Syntesi - the first unit with concealed interchangeable pneumatic fittings. New Deal - metal unit for heavy-duty applications. BIT - in a light engineering polymer, with millions sold. ONE - the only integrated unit in the world (3 patents). Skillair - modular unit with flow rates up to 20,000 NI/min. Regtronic - a range of 2" M5 proportional valves. Line On Line - miniature regulation system. New products will be launched throughout 2020, the year dedicated to air treatment, including FLUX flow meters, and more specifically, FLUX 0 for flow rates up to 200 NI/min, FLUX 1 for flow rates up to 1000 NI/min and FLUX 2 for flow rates up to 3000 NI/min.

We believe that this campaign, which aims to improve users' technical knowledge, can help to ensure that the large amount of sensors and actuators that form the submerged part of the i4.0 iceberg, are increasingly reliable and high-performing.



Figure 10: 2020 - year of compressed air treatment.

Our sales network.

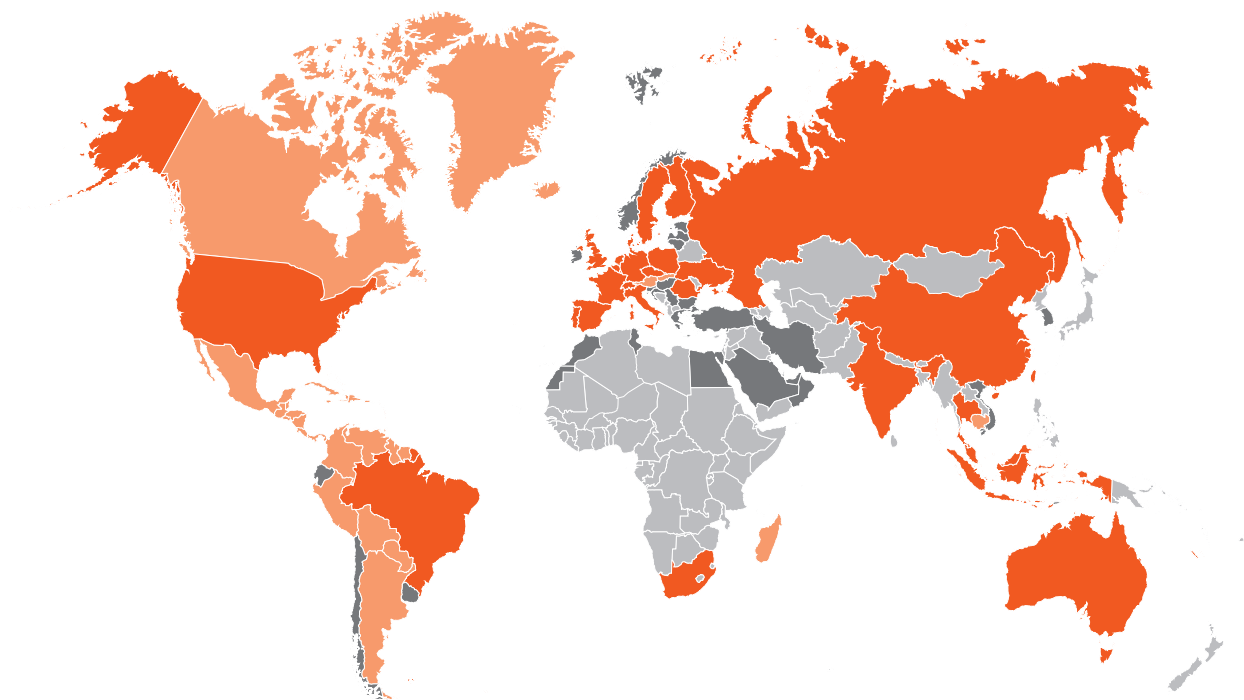

■ Group of companies Metal Work ■ Authorized dealer

Our subsidiaries in Italy



Bari
Bergamo
Bologna
Brescia
Cremona

Lecco
- Varese
Mantova
Modena
Monza Brianza

Novara
Parma
Prato
Rimini
Torino

Treviso
Verona
Vicenza

Our subsidiaries in the world



Australia
Belgio
Brasile
Cina
Danimarca
Finlandia
Francia

Germania
India
Indonesia
Malesia
Olanda
Polonia
Portogallo

Repubblica Ceca
Romania
Russia
Spagna
Sud Africa
Svezia
Svizzera

Tailandia
Ucraina
Uk
Usa
Vietnam

